



T&S BRASS AND BRONZE WORKS, INC.
 2 Saddleback Cove / P.O. Box 1088
 Travelers Rest, SC 29690

Model No.
B-0736-POL

Item No.

Travelers Rest, SC: 800-476-4103 • Simi Valley, CA: 800-423-0150 • Fax: 864-834-3518 • www.tsbrass.com

This Space for Architect/Engineer Approval

Job Name _____ Date _____

Model Specified _____ Quantity _____

Customer/Wholesaler _____

Contractor _____

Architect/Engineer _____

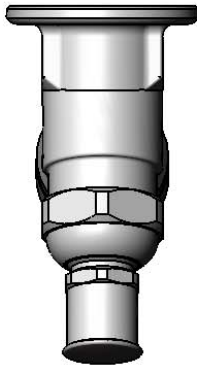

Ø 2" [51mm]
 Flanges w/
 1/2" NPT
 Female Inlet

Loose Key
 Stop Shut-Off

Vacuum Breaker
 w/ Garden Hose
 Male Outlet

3 5/8"
 [93mm]

1 7/8"
 [48mm]

Product Specifications:

Single Hole Single Temperature Wall Mount Sill Faucet, Loose Key Stop Shut-Off, Vacuum Breaker w/ Garden Hose Male Outlet, Polished Chrome Finish & 1/2" NPT Female Inlet

Product Compliance:

ASME A112.18.1 / CSA B125.1
 NSF 61 - Section 9
 NSF 372 (Low Lead Content)
 ASSE 1011 (VB)



T&S BRASS AND BRONZE WORKS, INC.
 2 Saddleback Cove / P.O. Box 1088
 Travelers Rest, SC 29690

Model No.
B-0736-POL

Item No.

Travelers Rest, SC: 800-476-4103 • Simi Valley, CA: 800-423-0150 • Fax: 864-834-3518 • www.tsbrass.com

ITEM NO.	SALES NO.	DESCRIPTION
1	001605-45	Cap
2	124A	Loose Key Cartridge, RTC w/ T-Handle, Screw & Cap
3	B-0972	Vacuum Breaker, 3/4" Garden Hose Male Outlet

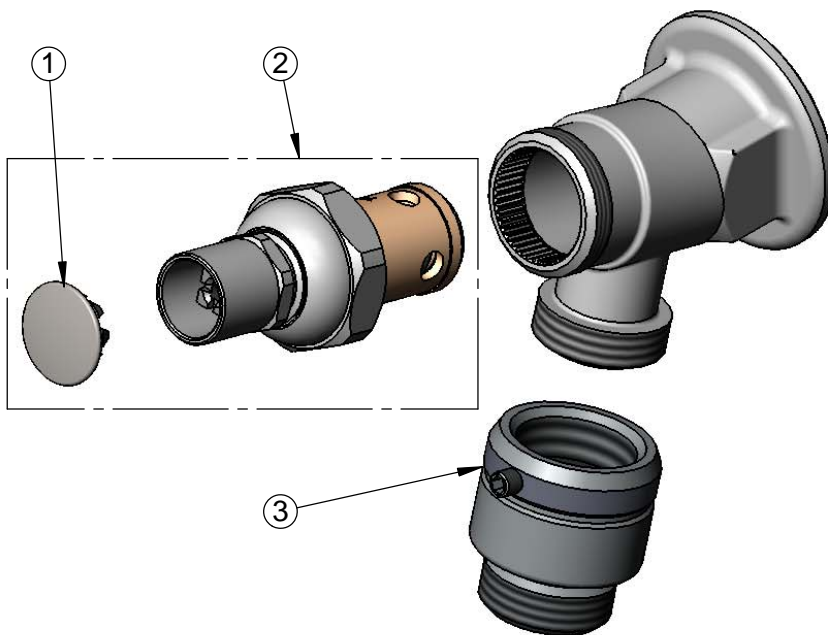

002432-45
T-Handle Screw



001802-45
T-Handle

Product Specifications:
 Single Hole Single Temperature Wall Mount Sill Faucet, Loose Key Stop Shut-Off, Vacuum Breaker w/ Garden Hose Male Outlet, Polished Chrome Finish & 1/2" NPT Female Inlet

Product Compliance:
 ASME A112.18.1 / CSA B125.1
 NSF 61 - Section 9
 NSF 372 (Low Lead Content)
 ASSE 1011 (VB)